

# VENETIAN BLINDS

## VENETIAN TOP TRACK PROFILE WITH COMPONENTS SH-BA11-0133

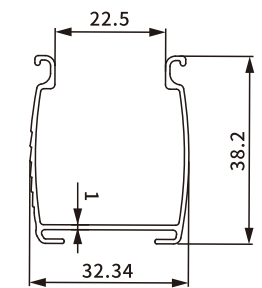

Item No.: SH-BA11-0133  
Weight: 0.328kg/m

## END CAPS

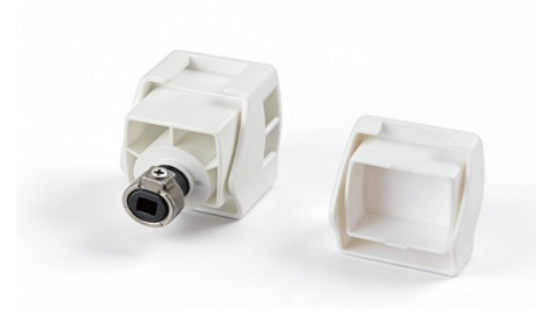

Item No.: SH-BA12-0030

## VENETIAN TOP TRACK PROFILE WITH COMPONENTS SH-BA11-0134

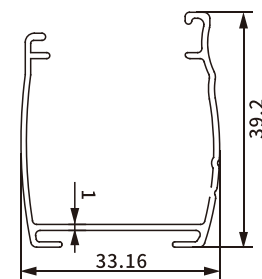
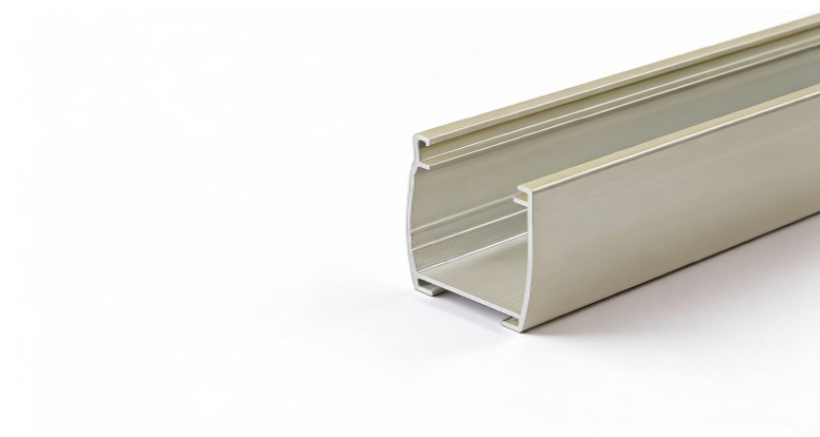

Item No.: SH-BA11-0134  
Weight: 0.332kg/m

## END CAPS

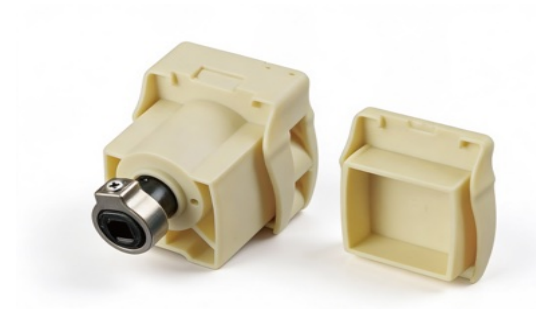

Item No.: SH-BA12-0031



**VENETIAN TOP TRACK PROFILE WITH COMPONENTS SH-BA11-0135**

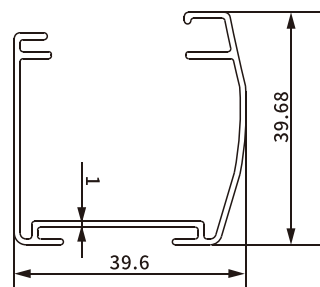
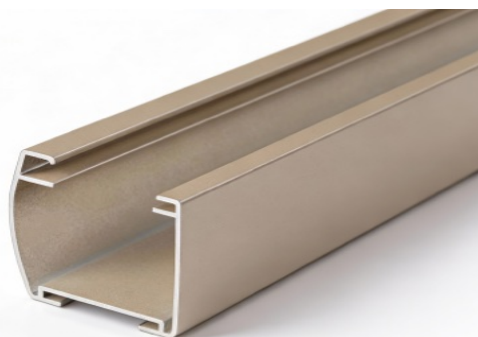

Item No.: SH-BA11-0135  
Weight: 0.416kg/m

**END CAPS**



Item No.: SH-BA12-0032

**VENETIAN BOTTOM RAIL PROFILE WITH COMPONENTS SH-BA11-0136**

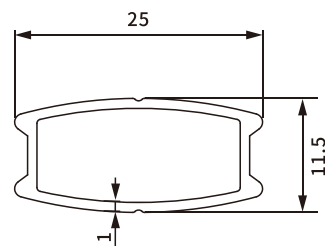

Item No.: SH-BA11-0136  
Weight: 0.182kg/m

**END CAPS**



Item No.: SH-BA12-0033

**VENETIAN BOTTOM RAIL PROFILE WITH COMPONENTS SH-BA11-0137**

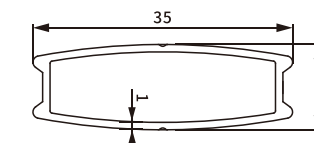

Item No.: SH-BA11-0137  
Weight: 0.237kg/m

**END CAPS**



Item No.: SH-BA12-0034

**VENETIAN TOP TRACK PROFILE SH-BA11-0138**

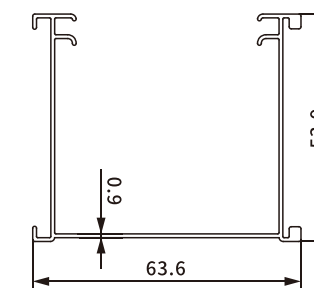

Item No.: SH-BA11-0138  
Weight: 0.544kg/m

**VENETIAN BOTTOM TRACK PROFILE SH-BA11-0139**

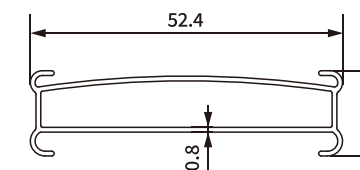

Item No.: SH-BA11-0139  
Weight: 0.301kg/m

# VENETIAN BLINDS COMPONENTS

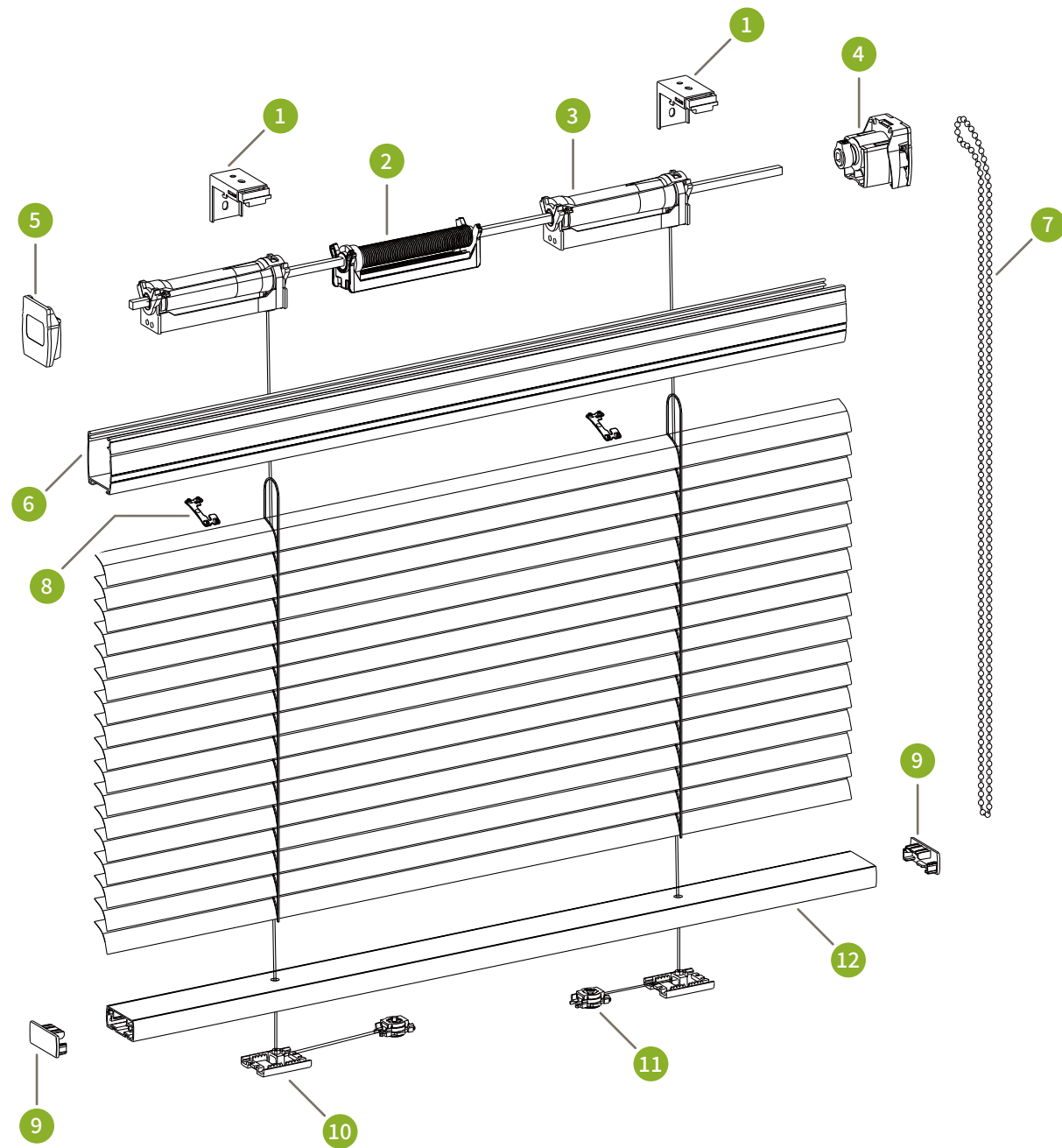

- 1 Bracket
- 2 Limiter
- 3 Roller
- 4 Clutch
- 5 End Cap
- 6 Headrail
- 7 Ball Chain
- 8 Butterfly
- 9 End Cap
- 10 Cord button for venetian
- 11 Cord adjuster for venetian
- 12 Bottom Rail

## COMPATIBILITY

For 25 & 35mm Venetian Blinds  
Suitable for C, S, L slat

## STRUCTURE & MATERIAL

Made with PA66+GF, PC, and POM  
5 planetary gears inside  
1:3.5 reduction ratio; energy saving up to 55%

## PERFORMANCE

Service life up to 15,000 cycles  
7KG Maximum Weight  
Light operation, smooth movement, low noise

## HEADRAIL COMPONENTS FOR 25 & 35MM VENETIAN BLINDS

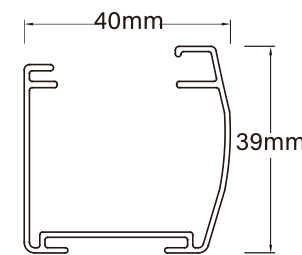

**Aluminum Headrail**

Item No.:  
SH-BA11-0135

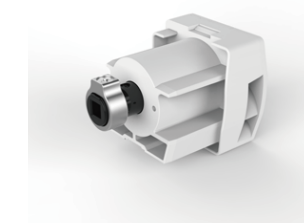

**Clutch (Right)**

Item No.:  
SH-BE1-0009

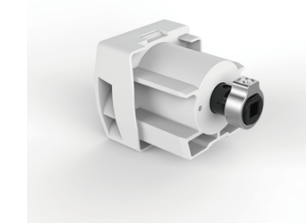

**Clutch (Left)**

Item No.:  
SH-BE1-0010

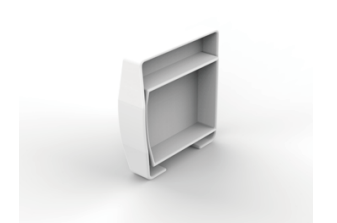

**Headrail End Cap (Right)**

Item No.:  
SH-BE1-0011

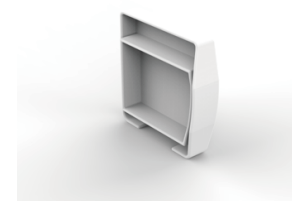

**Headrail End Cap (Left)**

Item No.:  
SH-BE1-0012



**Wall Bracket**

Item No.:  
SH-BE1-0013



**Ceiling Bracket**

Item No.:  
SH-BE1-0014

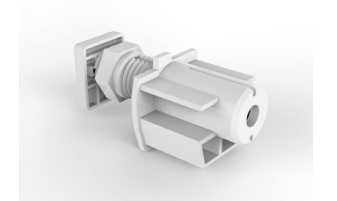

**Easy-fix System (Right)**

Item No.:  
SH-BE1-0015  
Width ≤ 160cm Weight < 3kg

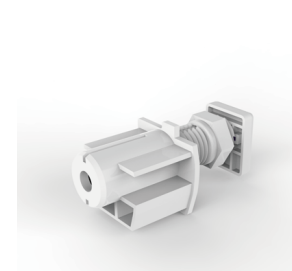

**Easy-fix System (Left)**

Item No.:  
SH-BE1-0016



**Ball Chain**

Item No.:  
SH-BE1-0059

# VENETIAN BLINDS COMPONENTS

## ROLLER FOR 25 & 35MM VENETIAN BLINDS

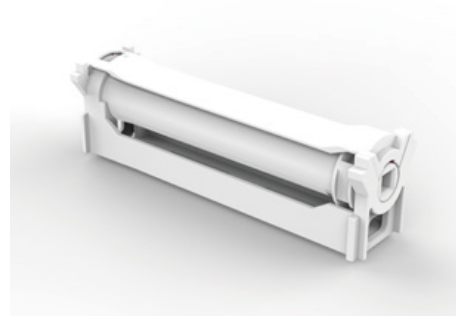

### Roller Generation 3th

Item No.: SH-BE1-0017  
Maximum Lift Height: 454.2cm

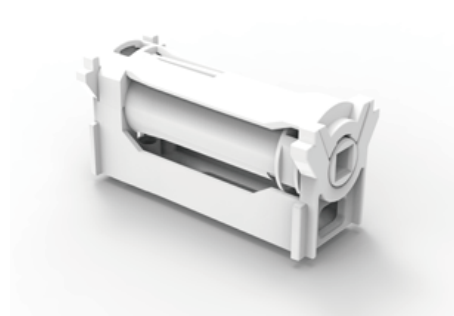

### Roller Generation 4th

Item No.: SH-BE1-0018  
Maximum Lift Height: 243.3cm

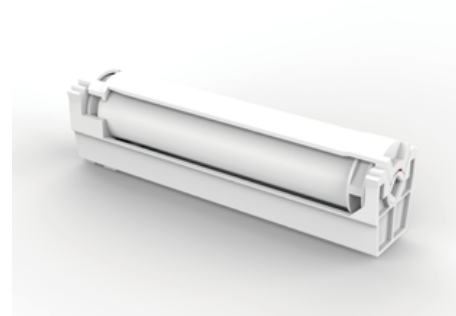

### Roller Generation 5th

Item No.: SH-BE1-0019  
Maximum Lift Height: 605cm



### Roller Generation 8th-Bearing

Item No.: SH-BE1-0020  
Maximum Lift Height: 450cm

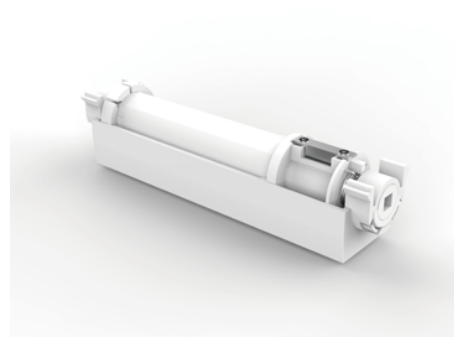

### Ladder Tape Roller

Item No.: SH-BE1-0021  
Maximum Lift Height: 307cm



### Ladder Cord Supporter

Item No.: SH-BE1-0022

## BUTTERFLY FOR 25MM VENETIAN BLINDS



### 25mm Butterfly for "C" Shape Slat

Item No.: SH-BE1-0023



### 25mm Butterfly for "S" Shape Slat

Item No.: SH-BE1-0024



### 25mm Butterfly for "L" Shape Slat

Item No.: SH-BE1-0025

## BUTTERFLY FOR 35MM VENETIAN BLINDS



### 35mm Butterfly for "C" Shape Slat

Item No.: SH-BE1-0026



### 35mm Butterfly for "S" Shape Slat

Item No.: SH-BE1-0027



### 35mm Butterfly for "L" Shape Slat

Item No.: SH-BE1-0028

## LIMITER FOR 25 & 35MM VENETIAN BLINDS

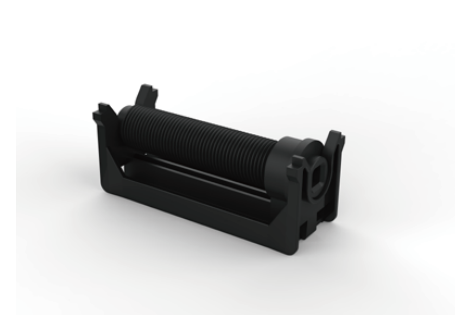

### Short Limiter-75mm

Item No.: SH-BE1-0029  
Maximum Lift Height: 270cm



### Long Limiter-113mm

Item No.: SH-BE1-0030  
Maximum Lift Height: 420cm



### Extra-long Limiter-139mm

Item No.: SH-BE1-0031  
Maximum Lift Height: 650cm

# VENETIAN BLINDS COMPONENTS

## BOTTOM RAIL COMPONENTS FOR 25MM VENETIAN BLINDS

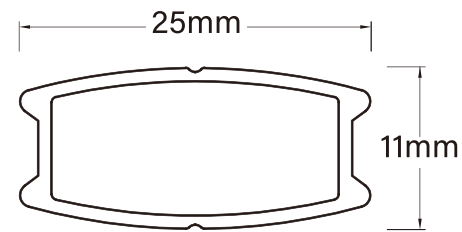

**Aluminum Bottom Rail (25mm)**

Item No.: SH-BA11-0136

**Bottom Rail End Cap (25mm)**

Item No.: SH-BE1-0032

**Cord Cover on Bottom Rail**

Item No.: SH-BE1-0033

## BOTTOM RAIL COMPONENTS FOR 35MM VENETIAN BLINDS

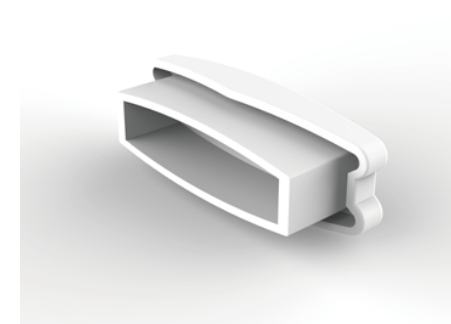
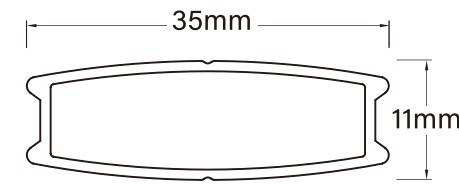

**Aluminum Bottom Rail (35mm)**

Item No.: SH-BA11-0137

**Bottom Rail End Cap (35mm)**

Item No.: SH-BE1-0037

**Cord Button for Venetian**

Item No.: SH-BE1-0034

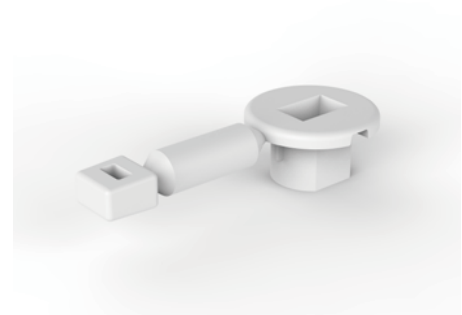

**Cord Button for Venetian**

Item No.: SH-BE1-0034

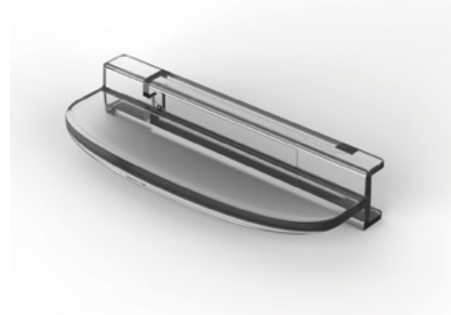

**Handle**

Item No.: SH-BE1-0035



**Handle Base**

Item No.: SH-BE1-0036



**Cord Adjust Button**

Item No.: SH-BE1-0038



**Cord Cover on Bottom Rail**

Item No.: SH-BE1-0033