

HONEYCOMB SHADES

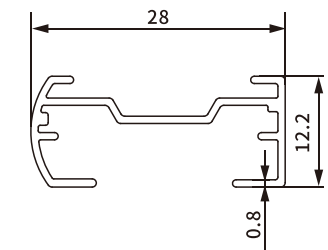

2.5 HONEYCOMB SHADES BOTTOM TRACK PROFILE WITH COMPONENTS SH-BA11-0140

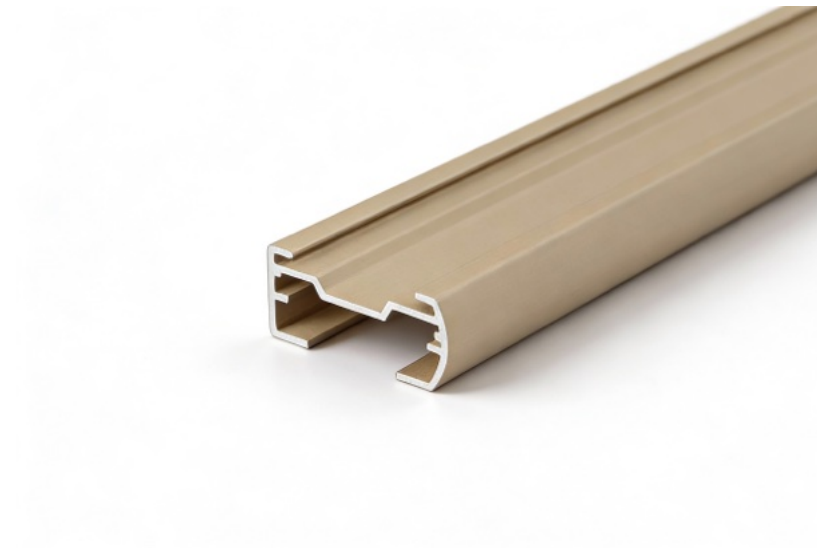

Item No.: SH-BA11-0140
Weight: 0.163kg/m

END CAPS



Item No.: SH-BA12-0035

HONEYCOMB SHADES PROFILE SH-BA11-0141

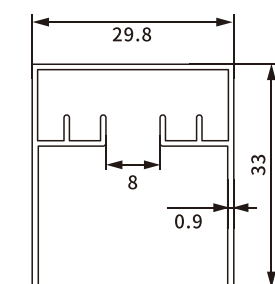

Item No.: SH-BA11-0141
Weight: 0.293kg/m

HONEYCOMB SHADES PROFILE SH-BA11-0142

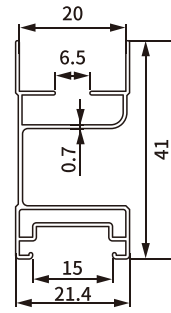

Item No.: SH-BA11-0142
Weight: 0.288 kg/m

HONEYCOMB SHADES PROFILE SH-BA11-0146

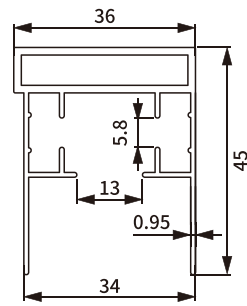

Item No.: SH-BA11-0146
Weight: 0.174kg/m

HONEYCOMB SHADES PROFILE SH-BA11-0145

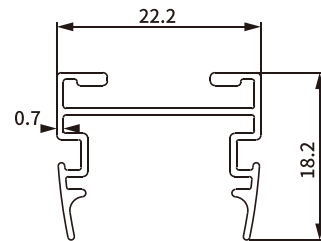

Item No.: SH-BA11-0145
Weight: 0.174kg/m

HONEYCOMB SHADES PROFILE SH-BA11-0143 SH-BA11-0144

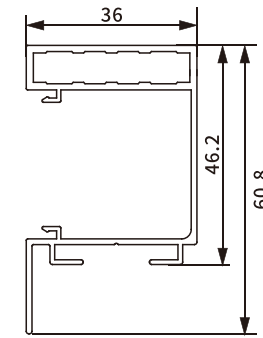

Item No.: SH-BA11-0143
Weight: 0.699kg/m

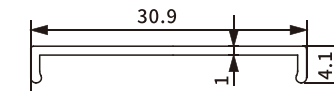

Item No.: SH-BA11-0144
Weight: 0.101kg/m

HONEYCOMB SHADES PROFILE SH-BA11-0147

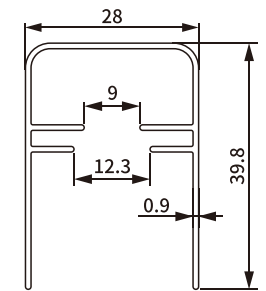
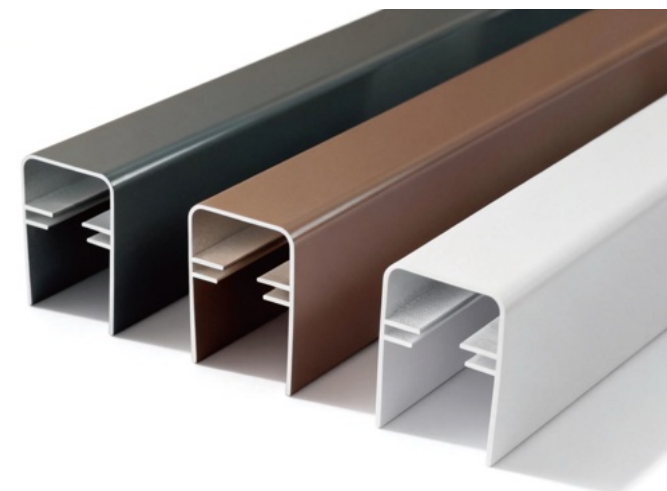

Item No.: SH-BA11-0147
Weight: 0.328kg/m

VENETIAN BLINDS & HONEYCOMB SHADES PROFILE

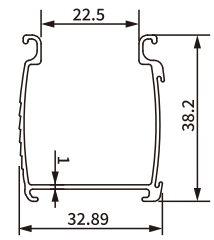

Item No.: SH-BA11-0148
Weight: 0.349kg/m

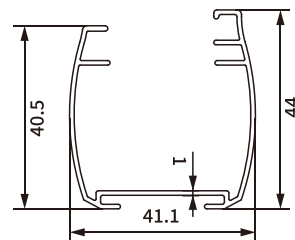

Item No.: SH-BA11-0149
Weight: 0.438kg/m

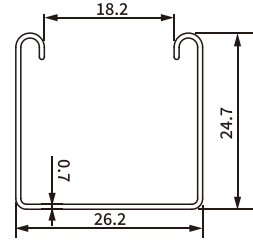

Item No.: SH-BA11-0150
Weight: 0.158kg/m

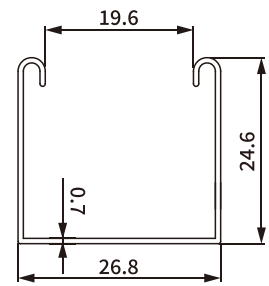

Item No.: SH-BA11-0151
Weight: 0.160kg/m

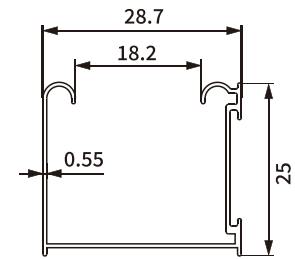

Item No.: SH-BA11-0152
Weight: 0.149kg/m

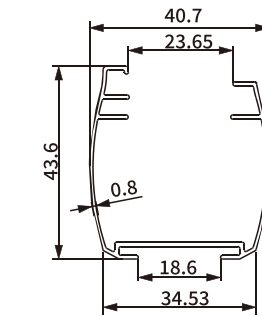

Item No.: SH-BA11-0153-0.8
Weight: 0.378kg/m

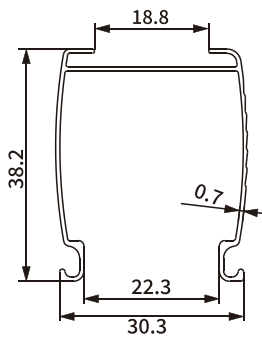

Item No.: SH-BA11-0154-0.7
Weight: 0.244kg/m

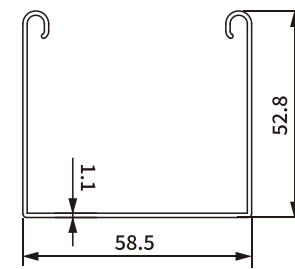

Item No.: SH-BA11-0155
Weight: 0.537kg/m

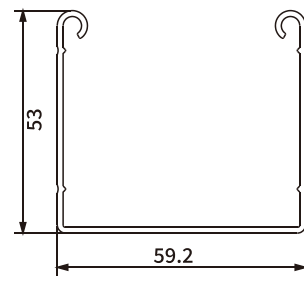

Item No.: SH-BA11-0156
Weight: 0.680kg/m

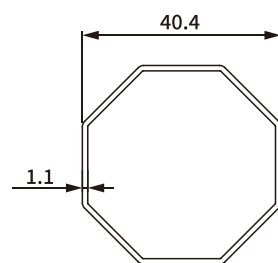

Item No.: SH-BA11-0157
Weight: 0.387kg/m

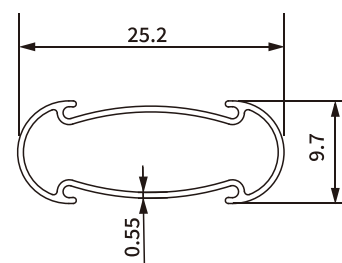

Item No.: SH-BA11-0158
Weight: 0.106kg/m

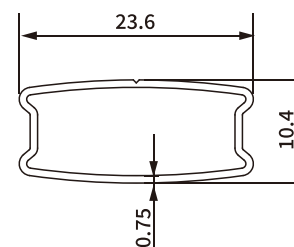

Item No.: SH-BA11-0159
Weight: 0.128kg/m

VENETIAN BLINDS & HONEYCOMB SHADES PROFILE

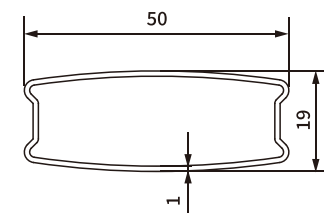

Item No.: SH-BA11-0160
Weight: 0.348kg/m

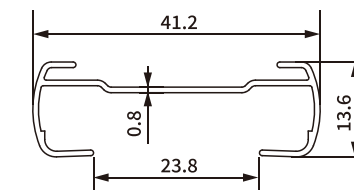

Item No.: SH-BA11-0161
Weight: 0.193kg/m

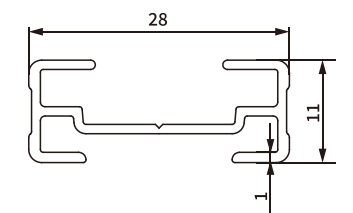

Item No.: SH-BA11-0162
Weight: 0.201kg/m

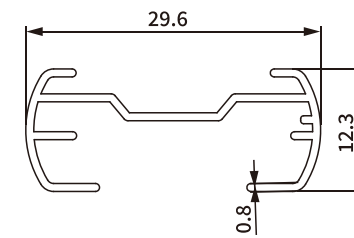

Item No.: SH-BA11-0163
Weight: 0.165kg/m

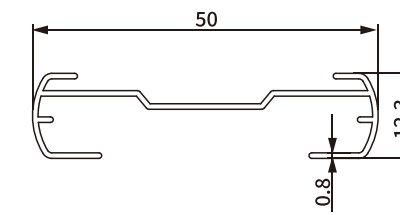

Item No.: SH-BA11-0164
Weight: 0.245kg/m

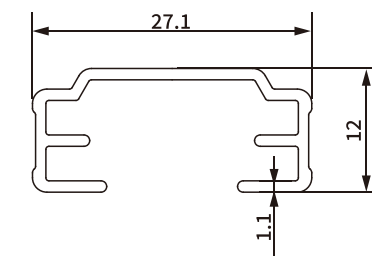

Item No.: SH-BA11-0165
Weight: 0.197kg/m

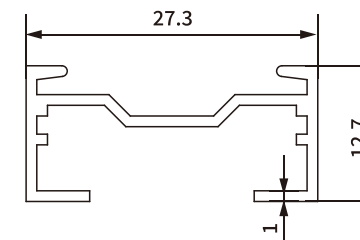

Item No.: SH-BA11-0166
Weight: 0.198kg/m

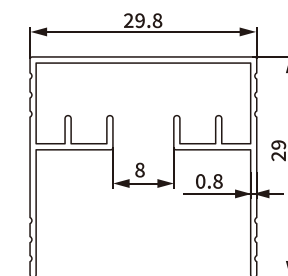

Item No.: SH-BA11-0167
Weight: 0.259kg/m

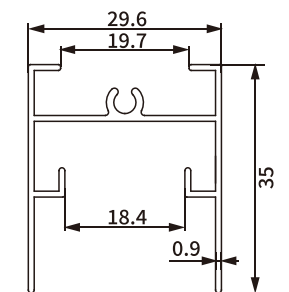

Item No.: SH-BA11-0168-0.9
Weight: 0.331kg/m

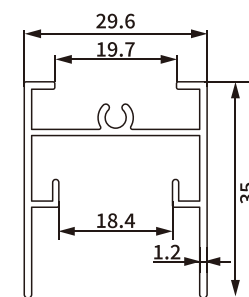

Item No.: SH-BA11-0168
Weight: 0.399kg/m

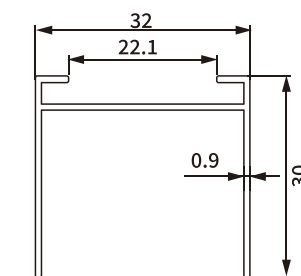

Item No.: SH-BA11-0169
Weight: 0.243kg/m

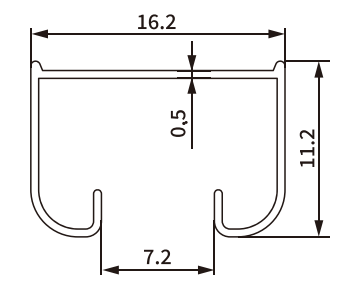

Item No.: SH-BA11-0170
Weight: 0.065kg/m

VENETIAN BLINDS & HONEYCOMB SHADES PROFILE

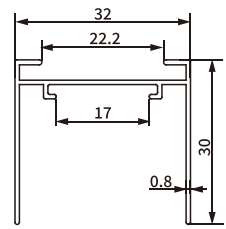

Item No.: SH-BA11-0171
Weight: 0.234kg/m

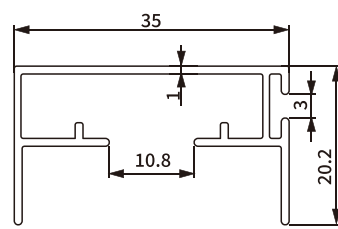

Item No.: SH-BA11-0172
Weight: 0.278kg/m

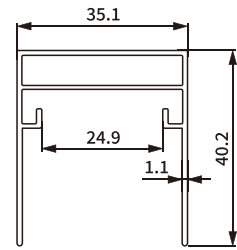

Item No.: SH-BA11-0173
Weight: 0.433kg/m

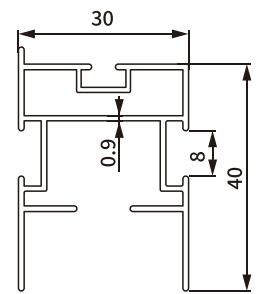

Item No.: SH-BA11-0174
Weight: 0.484kg/m

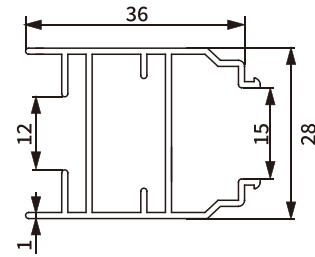

Item No.: SH-BA11-0175
Weight: 0.435kg/m

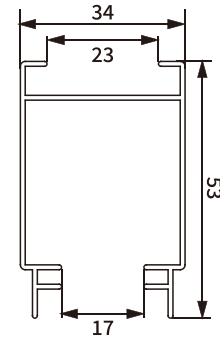

Item No.: SH-BA11-0176
Weight: 0.465kg/m

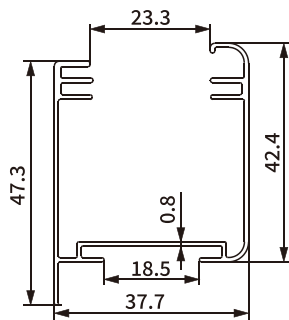

Item No.: SH-BA11-0177-0.8
Weight: 0.409kg/m

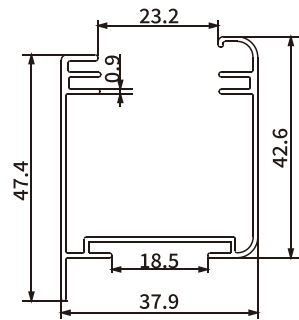

Item No.: SH-BA11-0177
Weight: 0.452kg/m

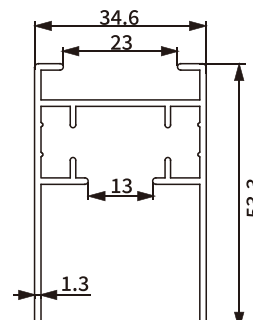

Item No.: SH-BA11-0178
Weight: 0.639kg/m

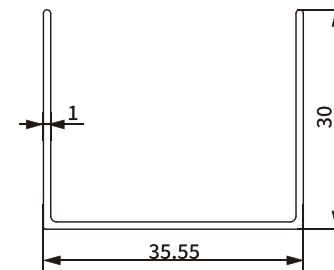

Item No.: SH-BA11-0189
Weight: 0.255kg/m

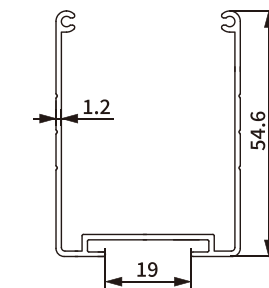

Item No.: SH-BA11-0190
Weight: 0.559kg/m

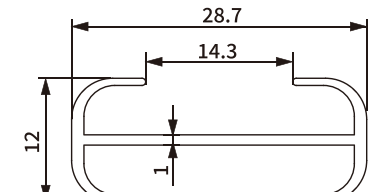

Item No.: SH-BA11-0191
Weight: 0.179kg/m

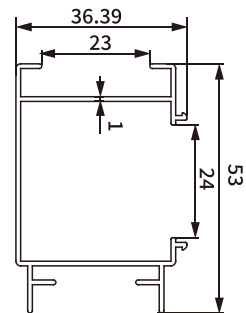

Item No.: SH-BA11-0179
Weight: 0.461kg/m

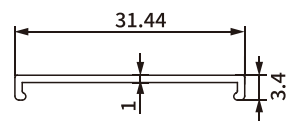

Item No.: SH-BA11-0180
Weight: 0.101kg/m

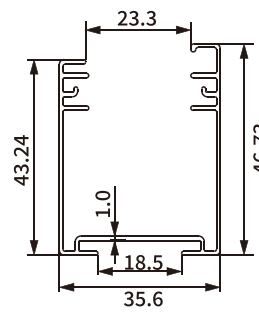

Item No.: SH-BA11-0181
Weight: 0.426kg/m

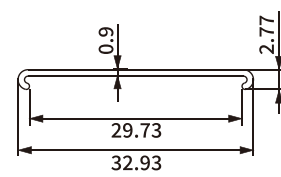

Item No.: SH-BA11-0182
Weight: 0.089kg/m

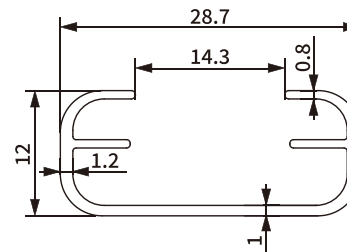

Item No.: SH-BA11-0192
Weight: 0.184kg/m

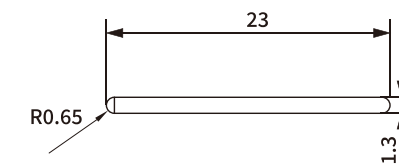

Item No.: SH-BA11-0193
Weight: 0.081kg/m

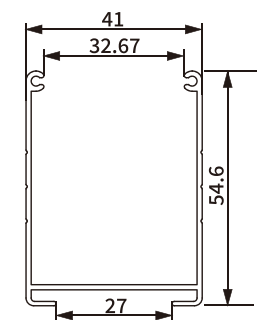

Item No.: SH-BA11-0194
Weight: 0.544kg/m

VENETIAN BLINDS & HONEYCOMB SHADES PROFILE

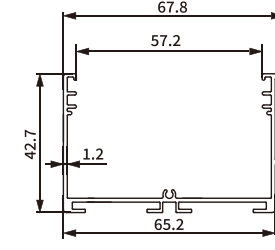

Item No.: SH-BA11-0183
Weight: 0.666kg/m

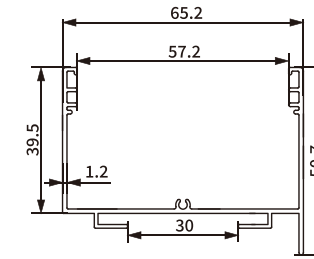

Item No.: SH-BA11-0184
Weight: 0.634kg/m

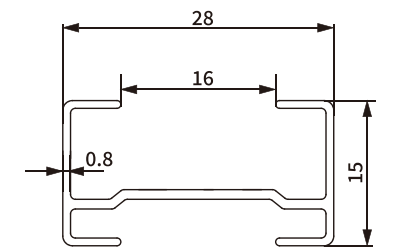

Item No.: SH-BA11-0185
Weight: 0.183kg/m

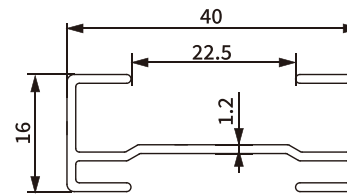

Item No.: SH-BA11-0186
Weight: 0.326kg/m

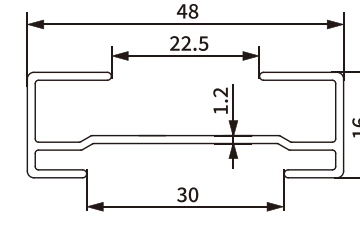

Item No.: SH-BA11-0187
Weight: 0.380kg/m

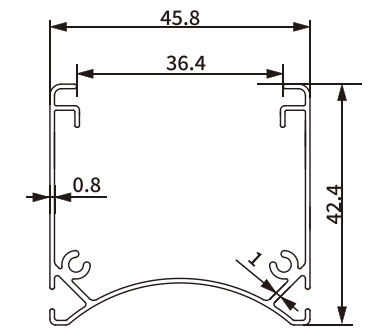

Item No.: SH-BA11-0188
Weight: 0.436kg/m

VENETIAN BLINDS & HONEYCOMB SHADES PROFILE

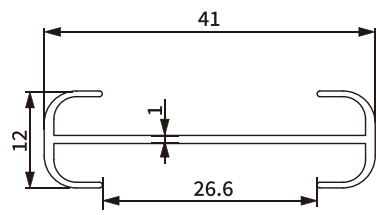

Item No.: SH-BA11-0195
Weight: 0.210kg/m

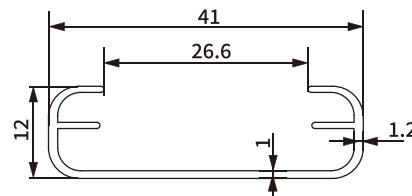

Item No.: SH-BA11-0196
Weight: 0.217kg/m

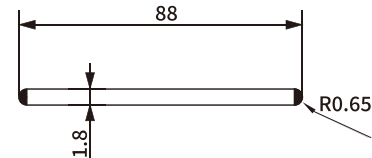

Item No.: SH-BA11-0197
Weight: 0.123kg/m

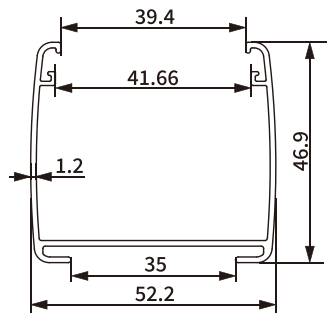

Item No.: SH-BA11-0198
Weight: 0.559kg/m

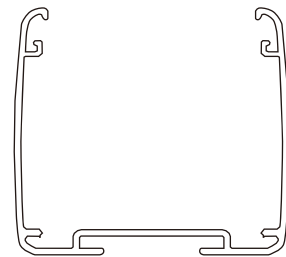

Item No.: SH-BA11-0234
Weight: 0.585kg/m

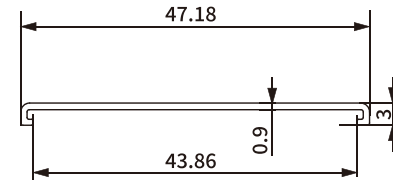

Item No.: SH-BA11-0199
Weight: 0.127kg/m

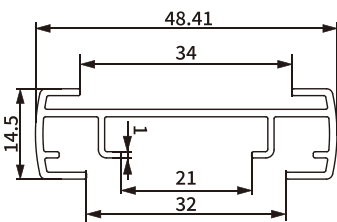

Item No.: SH-BA11-0200
Weight: 0.374kg/m

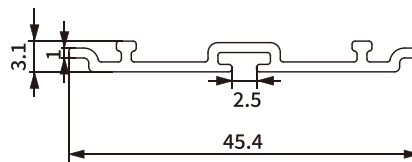

Item No.: SH-BA11-0201
Weight: 0.134kg/m

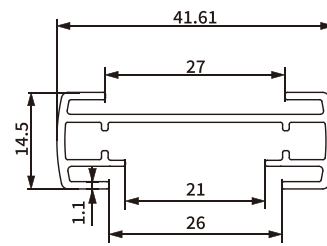

Item No.: SH-BA11-0202
Weight: 0.352kg/m

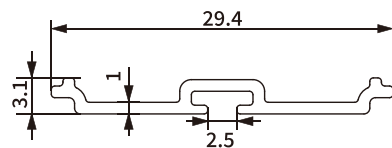

Item No.: SH-BA11-0203
Weight: 0.104kg/m

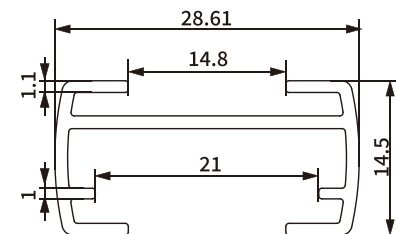

Item No.: SH-BA11-0204
Weight: 0.251kg/m

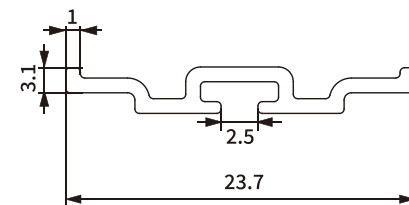

Item No.: SH-BA11-0205
Weight: 0.090kg/m



HONEYCOMB SHADES COMPONENTS

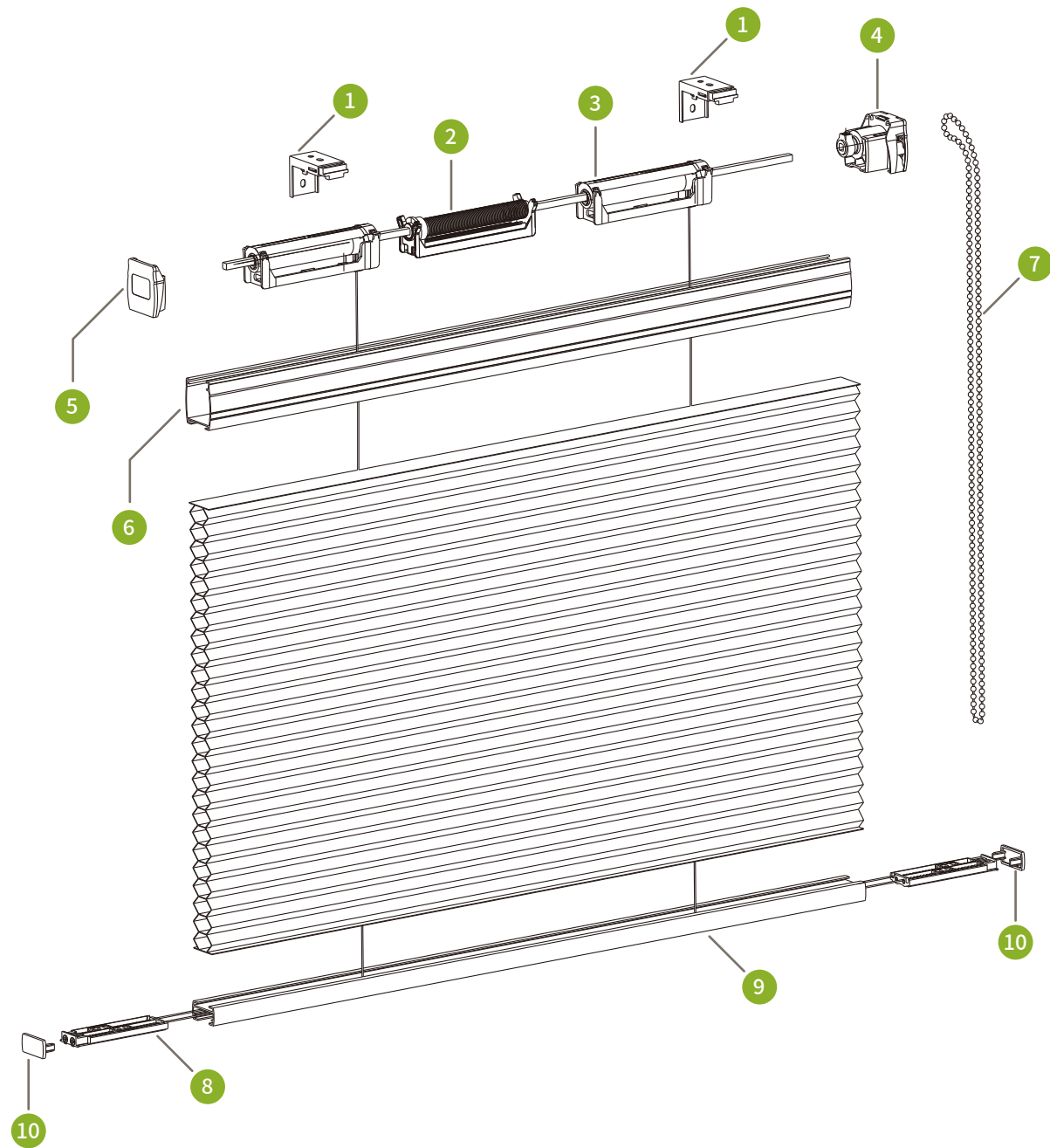

- 1 Bracket
- 2 Limiter
- 3 Roller
- 4 Clutch
- 5 End Cap
- 6 Headrail
- 7 Ball Chain
- 8 Roller String Adjuster
- 9 Bottom Rail
- 10 End Cap

COMPATIBILITY

For 25mm Honeycomb Shades

HEADRAIL COMPONENTS FOR 25MM HONEYCOMB SHADES

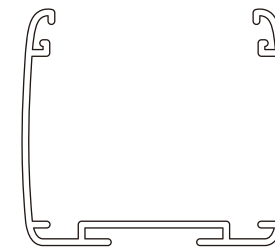

Aluminum Headrail

Item No.:
SH-BA11-0234



Bracket

Item No.:
SH-BE1-0061



Ball Chain

Item No.:
SH-BE1-0059

BOTTOM RAIL COMPONENTS FOR 25MM HONEYCOMB SHADES

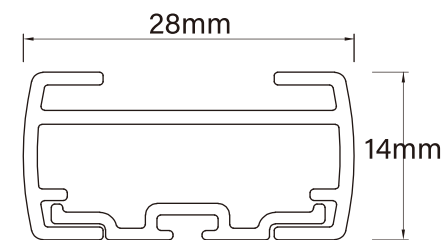

Aluminum Bottom Rail (25mm)

Item No.:
SH-BA11-0204 + SH-BA11-0205

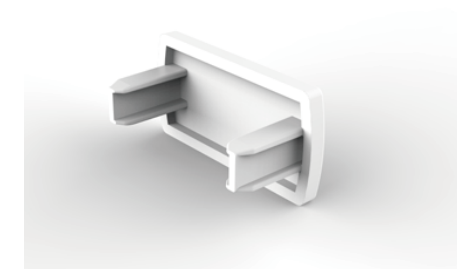

Bottom Rail End Cap (25mm)

Item No.:
SH-BE1-0040



Cord Adjuster

Item No.:
SH-BE1-0041

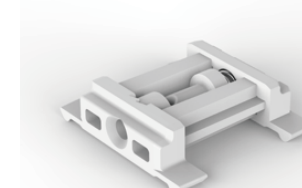

Cord Adjuster 02

Item No.:
SH-BE1-0042

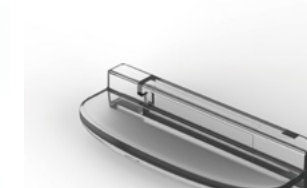

Handle

Item No.:
SH-BE1-0035

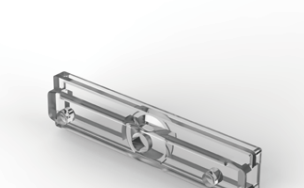

Handle Base

Item No.:
SH-BE1-0036

HONEYCOMB SHADES COMPONENTS

BOTTOM RAIL COMPONENTS FOR 38MM HONEYCOMB SHADES

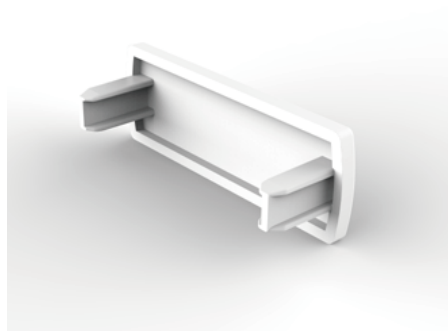
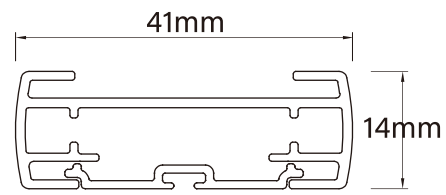

Aluminum Bottom Rail (38mm)

Item No.:
SH-BA11-0202
+ SH-BA11-0203

Bottom Rail End Cap (38mm)

Item No.:
SH-BE1-0043

Cord Adjuster

Item No.:
SH-BE1-0041

BOTTOM RAIL COMPONENTS FOR 45MM HONEYCOMB SHADES

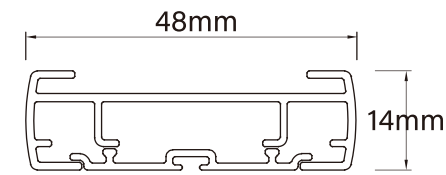

Aluminum Bottom Rail (45mm)

Item No.:
SH-BA11-0200 + SH-BA11-0201

Bottom Rail End Cap (45mm)

Item No.:
SH-BE1-0044

Cord Adjuster

Item No.:
SH-BE1-0041

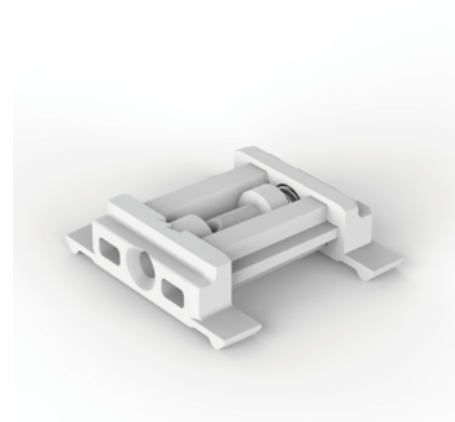

Cord Adjuster 02

Item No.:
SH-BE1-0042



Handle

Item No.:
SH-BE1-0035



Handle Base

Item No.:
SH-BE1-0036

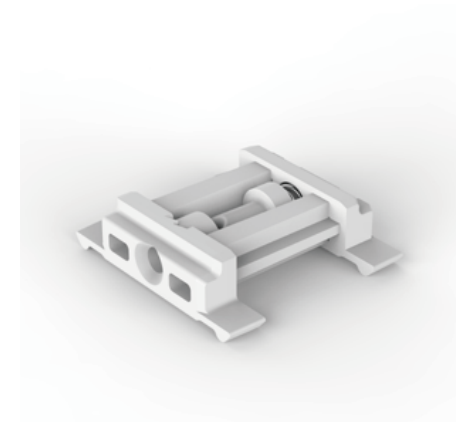

Cord Adjuster 02

Item No.:
SH-BE1-0042

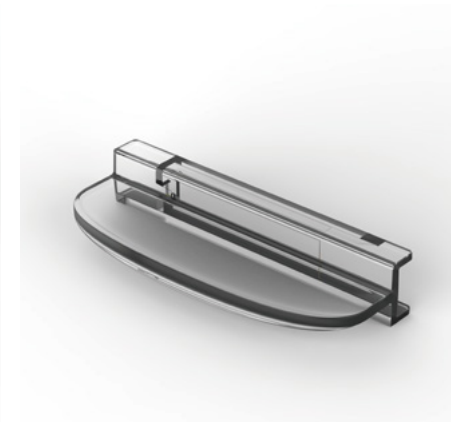

Handle

Item No.:
SH-BE1-0035

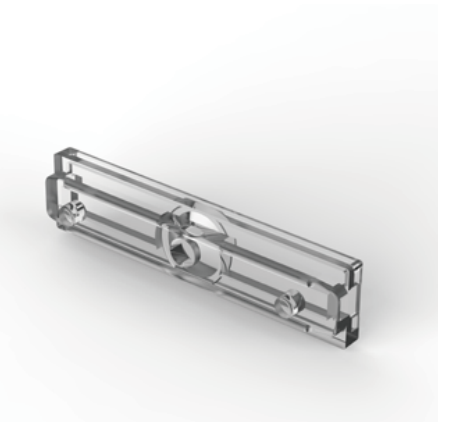

Handle Base

Item No.:
SH-BE1-0036